

**INDOOR UNIT OF CITY MULTI R410A SERIES**

**PWFY-P100VM-E-BU**

CE

**PWFY-P100VM-E-AU**

**PWFY-P200VM-E-AU**

---

## **INSTALLATION MANUAL**

For safe and correct use, please read this installation manual thoroughly before installing the indoor unit.

6

### 6.1

[Fig. 6.1.1]

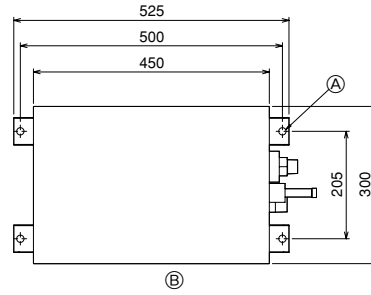

- Ⓐ 4-φ14 (Anchoring hole)
- Ⓑ (Top view)

### 6.2

[Fig. 6.2.1]

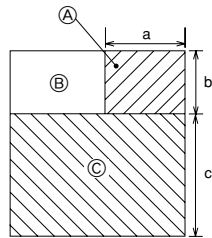

- Ⓐ Piping space (right side)
- Ⓑ Top view
- Ⓒ Service space (front side)

7

### 7.1

[Fig. 7.1.1]

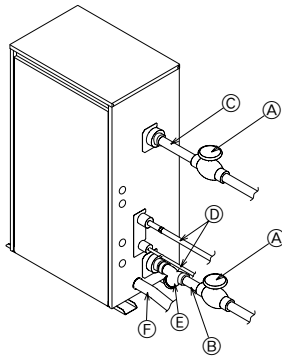

PWFY-P200VM-E-AU

[Fig. 7.1.2]

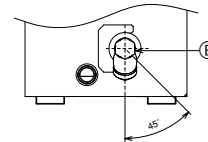
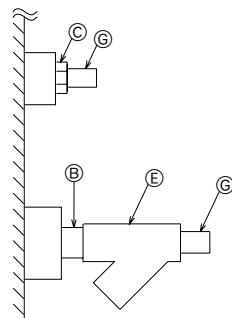

- Ⓐ Close valve
- Ⓑ Water inlet
- Ⓒ Water outlet
- Ⓓ Refrigerant piping
- Ⓔ Y-type strainer
- Ⓕ Drain pipe
- Ⓖ Expansion joint

### 7.2

[Fig. 7.2.1]

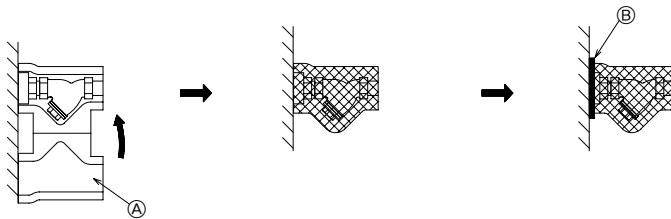

- Ⓐ Heat insulation material (accessory)
- Ⓑ Inject with cooling material

### 7.4

[Fig. 7.4.1]

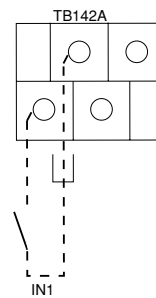

[Fig. 8.1.1]

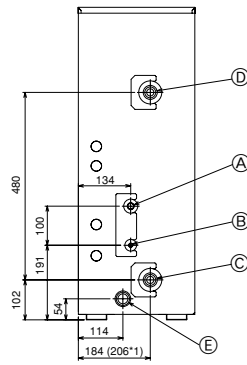

- Ⓐ Refrigerant piping (gas)
  - Ⓑ Refrigerant piping (liquid)
  - Ⓒ Water inlet
  - Ⓓ Water outlet
  - Ⓔ Drain outlet
- \*1: PWFY-P100/200VM-E-AU

[Fig. 9.1.1]

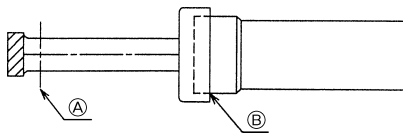

- Ⓐ Cut here
- Ⓑ Remove brazed cap

[Fig. 9.1.2]

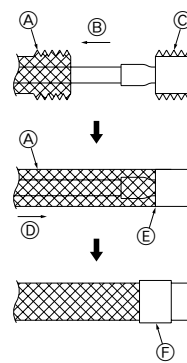

- Ⓐ Thermal insulation
- Ⓑ Pull out insulation
- Ⓒ Wrap with damp cloth
- Ⓓ Return to original position
- Ⓔ Ensure that there is no gap here
- Ⓕ Wrap with insulating tape

[Fig. 9.2.1]

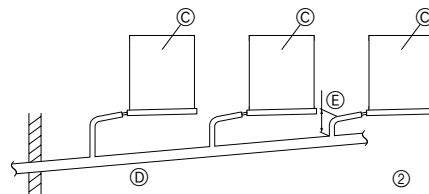
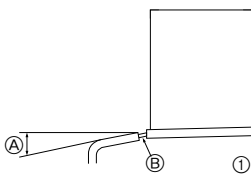

- Ⓐ Downward slope 1/100 or more
- Ⓑ Drain hose
- Ⓒ Unit
- Ⓓ Collective piping
- Ⓔ Maximize this length to approx. 10 cm

[Fig. 9.3.1]

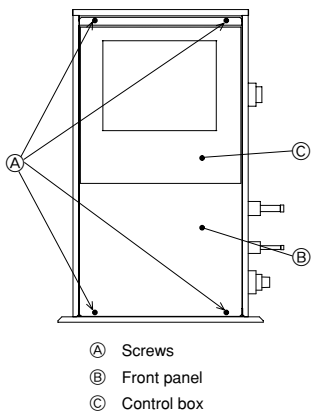

- Ⓐ Screws
- Ⓑ Front panel
- Ⓒ Control box

[Fig. 9.3.2]

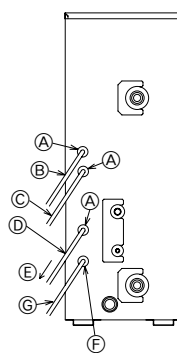

- Ⓐ To prevent external tensile force from applying to the wiring connection section of power source terminal block use buffer bushing like PG connection or the like.
- Ⓑ External signal input cable
- Ⓒ External signal output cable
- Ⓓ Power source wiring
- Ⓔ Tensile force
- Ⓕ Use ordinary bushing
- Ⓖ Transmission cable and MA remote controller cable

[Fig. 10.1.1]

PWFY- P100VM-E-BU

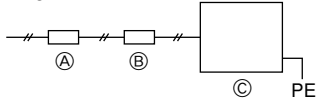

PWFY- P100/200VM-E-AU

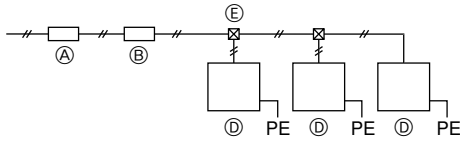

- (A) Breaker for current leakage
- (B) Local switch or breakers for wiring
- (C) PWFY-P100VM-E-BU
- (D) PWFY-P100/200VM-E-AU
- (E) Pull box

10.2

[Fig. 10.2.1]

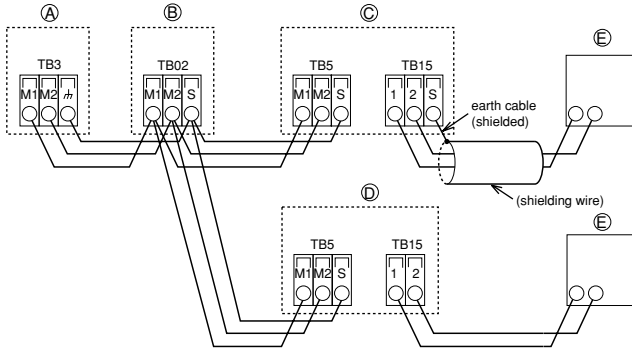

- (A) Outdoor unit
- (B) BC controller
- (C) PWFY-P100VM-E-BU
- (D) PWFY-P100/200VM-E-AU
- (E) MA remote controller

[Fig. 10.2.2]

PWFY- P100VM-E-BU

PWFY- P100/200VM-E-AU

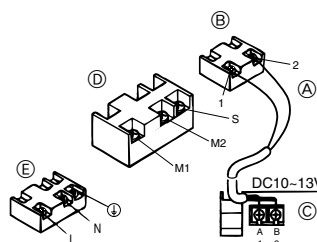
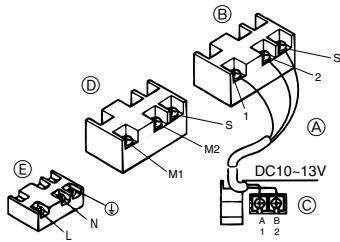

- (A) Non-polarized
- (B) TB15 (MA remote controller cables)
- (C) MA remote Controller
- (D) TB5 (Transmission cables)
- (E) TB2 (Power supply wiring)

10.3

[Fig. 10.3.1]

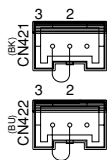

[Fig. 10.3.2]

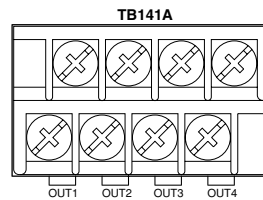

[Fig. 10.3.3]

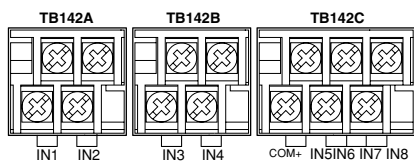

10.4

[Fig. 10.4.1]

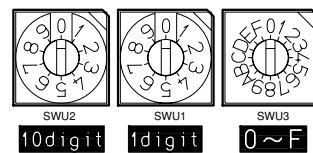

# Contents

1. Safety precautions .....	5	7.3. Water processing and water quality control .....	8
1.1. Before installation and electric work .....	5	7.4. Pump interlock .....	8
1.2. Precautions for devices that use R410A refrigerant .....	5	8. Refrigerant pipe and drain pipe specifications .....	9
1.3. Before getting installed .....	6	8.1. Refrigerant pipe, drain pipe and filling port .....	9
1.4. Before getting installed (moved) -electrical work .....	6	9. Connecting refrigerant pipes and drain pipes .....	9
1.5. Before starting the test run .....	6	9.1. Refrigerant piping work .....	9
2. About the product .....	6	9.2. Drain piping work .....	10
3. Specifications .....	7	9.3. Connecting electrical connections .....	10
4. Confirmation of parts attached .....	7	10. Electrical wiring .....	10
5. Lifting method .....	7	10.1. Power supply wiring .....	11
6. Installation of unit and service space .....	7	10.2. Connecting remote controller, indoor and outdoor transmission cables .....	11
6.1. Installation .....	7	10.3. External input/output function .....	11
6.2. Service space .....	7	10.4. Setting addresses .....	12
7. Water pipe installation .....	7	11. Information on rating plate .....	12
7.1. Precautions during installation .....	8		
7.2. Insulation installation .....	8		

## 1. Safety precautions

### 1.1. Before installation and electric work

- ▶ Before installing the unit, make sure you read all the “Safety precautions”.
- ▶ The “Safety precautions” provide very important points regarding safety. Make sure you follow them.

#### Symbols used in the text





##### Warning:

Describes precautions that should be observed to prevent danger of injury or death to the user.

##### Caution:

Describes precautions that should be observed to prevent damage to the unit.

#### Symbols used in the illustrations

-  : Indicates an action that must be avoided.
-  : Indicates that important instructions must be followed.
-  : Indicates a part which must be grounded.
-  : Beware of electric shock. (This symbol is displayed on the main unit label.)  
<Color: yellow>
-  : Beware of hot surface.

 **Warning:**  
Carefully read the labels affixed to the main unit.

##### Warning:

- **Do not use steel pipes as water pipes.**
  - Copper pipes are recommended.
- **The water circuit should be a closed circuit.**
- **Ask the dealer or an authorized technician to install the air conditioner.**
  - Improper installation by the user may result in water leakage, electric shock, or fire.
- **Install the unit in a place that can withstand its weight.**
  - Inadequate strength may cause the unit to fall down, resulting in injuries.
- **Do not touch the unit. The unit surface can be hot.**
- **Do not install the unit where corrosive gas is generated.**
- **Use the specified cables for wiring. Make the connections securely so that the outside force of the cable is not applied to the terminals.**
  - Inadequate connection and fastening may generate heat and cause a fire.
- **Prepare for rain and other moisture and earthquakes and install the unit at the specified place.**
  - Improper installation may cause the unit to topple and result in injury.
- **Always use a strainer and other accessories specified by Mitsubishi Electric.**
  - Ask an authorized technician to install the accessories. Improper installation by the user may result in water leakage, electric shock, or fire.
- **Never repair the unit. If the air conditioner must be repaired, consult the dealer.**
  - If the unit is repaired improperly, water leakage, electric shock, or fire may result.
- **Do not touch the refrigerant pipes and Water pipes.**
  - Improper handling may result in injury.
- **When handling this product, always wear protective equipment.**  
EG: Gloves, full arm protection namely boiler suit, and safety glasses.
  - Improper handling may result in injury.

- **If refrigerant gas leaks during installation work, ventilate the room.**
  - If the refrigerant gas comes into contact with a flame, poisonous gases will be released.
- **Install the unit according to this Installation Manual.**
  - If the unit is installed improperly, water leakage, electric shock, or fire may result.
- **Have all electric work done by a licensed electrician according to “Electric Facility Engineering Standard” and “Interior Wire Regulations” and the instructions given in this manual and always use a special circuit.**
  - If the power source capacity is inadequate or electric work is performed improperly, electric shock and fire may result.
- **Keep the electric parts away from water (washing water etc.).**
  - It might result in electric shock, catching fire or smoke.
- **Securely install the heat source unit terminal cover (panel).**
  - If the terminal cover (panel) is not installed properly, dust or water may enter the heat source unit and fire or electric shock may result.
- **When installing and moving the air conditioner to another site, do not charge it with a refrigerant different from the refrigerant (R410A) specified on the unit.**
  - If a different refrigerant or air is mixed with the original refrigerant, the refrigerant cycle may malfunction and the unit may be damaged.
- **If the air conditioner is installed in a small room, measures must be taken to prevent the refrigerant concentration from exceeding the safety limit even if the refrigerant should leak.**
  - Consult the dealer regarding the appropriate measures to prevent the safety limit from being exceeded. Should the refrigerant leak and cause the safety limit to be exceeded, hazards due to lack of oxygen in the room could result.
- **When moving and reinstalling the air conditioner, consult the dealer or an authorized technician.**
  - If the air conditioner is installed improperly, water leakage, electric shock, or fire may result.
- **After completing installation work, make sure that refrigerant gas is not leaking.**
  - If the refrigerant gas leaks and is exposed to a fan heater, stove, oven, or other heat source, it may generate noxious gases.
- **Do not reconstruct or change the settings of the protection devices.**
  - If the pressure switch, thermal switch, or other protection device is shorted and operated forcibly, or parts other than those specified by Mitsubishi Electric are used, fire or explosion may result.
- **To dispose of this product, consult your dealer.**
- **The installer and system specialist shall secure safety against leakage according to local regulation or standards.**
  - Following standards may be applicable if local regulation are not available.
- **Pay a special attention to the place, such as a basement, etc. where refrigeration gas can stay, since refrigeration is heavier than the air.**

### 1.2. Precautions for devices that use R410A refrigerant

##### Caution:

- **Do not use the existing refrigerant piping.**
  - The old refrigerant and refrigerant oil in the existing piping contains a large amount of chlorine which may cause the refrigerant oil of the new unit to deteriorate.
  - R410A is a high-pressure refrigerant and can cause the existing piping to burst.
- **Use refrigerant piping made of C1220 (CU-DHP) phosphorus deoxidized copper as specified in the JIS H3300 “Copper and copper alloy seamless pipes and tubes”. In addition, be sure that the inner and outer surfaces of the pipes are clean and free of hazardous sulphur, oxides, dust/dirt, shaving particles, oils, moisture, or any other contaminant.**
  - Contaminants on the inside of the refrigerant piping may cause the refrigerant residual oil to deteriorate.

- **Store the piping to be used during installation indoors and keep both ends of the piping sealed until just before brazing. (Store elbows and other joints in a plastic bag.)**
  - If dust, dirt, or water enters the refrigerant cycle, deterioration of the oil and compressor trouble may result.
- **Use ester oil, ether oil or alkylbenzene (small amount) as the refrigerant oil to coat flares and flange connections.**
  - The refrigerant oil will degrade if it is mixed with a large amount of mineral oil.
- **Use liquid refrigerant to fill the system.**
  - If gas refrigerant is used to seal the system, the composition of the refrigerant in the cylinder will change and performance may drop.
- **Do not use a refrigerant other than R410A.**
  - If another refrigerant (R22, etc.) is mixed with R410A, the chlorine in the refrigerant may cause the refrigerant oil to deteriorate.
- **Use a vacuum pump with a reverse flow check valve.**
  - The vacuum pump oil may flow back into the refrigerant cycle and cause the refrigerant oil to deteriorate.
- **Do not use the following tools that are used with conventional refrigerants.**  
(Gauge manifold, charge hose, gas leak detector, reverse flow check valve, refrigerant charge base, refrigerant recovery equipment)
  - If the conventional refrigerant and refrigerant oil are mixed in the R410A, the refrigerant may deteriorate.
  - If water is mixed in the R410A, the refrigerant oil may deteriorate.
  - Since R410A does not contain any chlorine, gas leak detectors for conventional refrigerants will not react to it.
- **Do not use a charging cylinder.**
  - Using a charging cylinder may cause the refrigerant to deteriorate.
- **Be especially careful when managing the tools.**
  - If dust, dirt, or water gets in the refrigerant cycle, the refrigerant may deteriorate.

### 1.3. Before getting installed

#### ⚠ Caution:

- **Do not install the unit where combustible gas may leak.**
  - If the gas leaks and accumulates around the unit, an explosion may result.
- **Do not use the air conditioner where food, pets, plants, precision instruments, or artwork are kept.**
  - The quality of the food, etc. may deteriorate.
- **Do not use the air conditioner in special environments.**
  - Oil, steam, sulfuric smoke, etc. can significantly reduce the performance of the air conditioner or damage its parts.
- **When installing the unit in a hospital, communication station, or similar place, provide sufficient protection against noise.**
  - The inverter equipment, private power generator, high-frequency medical equipment, or radio communication equipment may cause the air conditioner to operate erroneously, or fail to operate. On the other hand, the air conditioner may affect such equipment by creating noise that disturbs medical treatment or image broadcasting.
- **Do not install the unit on a structure that may cause leakage.**
  - When the room humidity exceeds 80 % or when the drain pipe is clogged, condensation may drip from the indoor unit. Perform collective drainage work together with the unit, as required.

### 1.4. Before getting installed (moved) - electrical work

#### ⚠ Caution:

- **Ground the unit.**
  - Do not connect the ground wire to gas or water pipes, lightning rods, or telephone ground lines. Improper grounding may result in electric shock.

## 2. About the product

- This unit uses R410A-type refrigerant
- Piping for systems using R410A may be different from that for systems using conventional refrigerant because the design pressure in systems using R410A is higher. Refer to Data Book for more information.
- Some of the tools and equipment used for installation with systems that use other types of refrigerant cannot be used with the systems using R410A. Refer to Data Book for more information.

- **Install the power cable so that tension is not applied to the cable.**
  - Tension may cause the cable to break and generate heat and cause a fire.
- **Install a leak circuit breaker, as required.**
  - If a leak circuit breaker is not installed, electric shock may result.
- **Use power line cables of sufficient current carrying capacity and rating.**
  - Cables that are too small may leak, generate heat, and cause a fire.
- **Use only a circuit breaker and fuse of the specified capacity.**
  - A fuse or circuit breaker of a larger capacity or a steel or copper wire may result in a general unit failure or fire.
- **Do not wash the air conditioner units.**
  - Washing them may cause an electric shock.
- **Be careful that the installation base is not damaged by long use.**
  - If the damage is left uncorrected, the unit may fall and cause personal injury or property damage.
- **Install the drain piping according to this Installation Manual to ensure proper drainage. Wrap thermal insulation around the pipes to prevent condensation.**
  - Improper drain piping may cause water leakage and damage to furniture and other possessions.
- **Be very careful about product transportation.**
  - Only one person should not carry the product if it weighs more than 20 kg.
  - Some products use PP bands for packaging. Do not use any PP bands for a means of transportation. It is dangerous.
  - When transporting the unit, support it at the specified positions on the unit base. Also support the unit at four points so that it cannot slip side ways.
- **Safely dispose of the packing materials.**
  - Packing materials, such as nails and other metal or wooden parts, may cause stabs or other injuries.
  - Tear apart and throw away plastic packaging bags so that children will not play with them. If children play with a plastic bag which was not torn apart, they face the risk of suffocation.

### 1.5. Before starting the test run

#### ⚠ Caution:

- **Turn on the power at least 12 hours before starting operation.**
  - Starting operation immediately after turning on the main power switch can result in severe damage to internal parts. Keep the power switch turned on during the operational season.
- **Do not touch the switches with wet fingers.**
  - Touching a switch with wet fingers can cause electric shock.
- **Do not touch the refrigerant pipes during and immediately after operation.**
  - During and immediately after operation, the refrigerant pipes are may be hot and may be cold, depending on the condition of the refrigerant flowing through the refrigerant piping, compressor, and other refrigerant cycle parts. Your hands may suffer burns or frostbite if you touch the refrigerant pipes.
- **Do not operate the air conditioner with the panels and guards removed.**
  - Rotating, hot, or high-voltage parts can cause injuries.
- **Do not turn off the power immediately after stopping operation.**
  - Always wait at least five minutes before turning off the power. Otherwise, water leakage and trouble may occur.
- **Do not touch the surface of the compressor during servicing.**
  - If unit is connected to the supply and not running, crank case heater at compressor is operating.
- **Do not touch the panels near the fan exhaust outlet with bare hands: they can get hot while the unit is in operation (even if it is stopped) or immediately after operation and poses a risk of burns. Wear gloves to protect your hands when it is necessary to touch the panels.**
- **While the unit is in operation or immediately after operation, high-temperature exhaust air may blow out of the fan exhaust outlet. Do not hold your hands over the outlet or touch the panels near the outlet.**
- **Be sure to provide a pathway for the exhaust air from the fan.**
- **Water pipes can get very hot, depending on the preset temperature. Wrap the water pipes with insulating materials to prevent burns.**

### 3. Specifications

Model		PWFY-P100VM-E-BU	PWFY-P100VM-E-AU	PWFY-P200VM-E-AU
Sound level		44dB<A>	29dB<A>	29dB<A>
Refrigerant		R134a × 1.1 kg	-	-
Net weight		60 kg	35 kg	38 kg
Design pressure	R410A MPa	4.15	4.15	4.15
	R134a MPa	3.60	-	-
	Water MPa	1.00	1.00	1.00
Connectable	Total capacity	50~100 % of outdoor unit capacity		
Outdoor unit	Model/Quantity	PURY-P*Y(S)HM-A (-BS)	PURY-P*Y(S)HM-A (-BS) PUHY-P*Y(S)HM-A (-BS)	
Temp. range of	Outdoor temp.	-20~32 °CWB (59~90 °F)	-20~32 °CWB (-4~90 °F) PURY - series -20~15.5 °CWB (-4~60 °F) PUHY - series	
Heating	Inlet Water temp.	10~70 °C (50~158 °F)	10~40 °C (50~104 °F)	
Temp. range of	Outdoor temp.	-	-5~43 °CDB (23~110 °F) PURY - series -5~43 °CDB (23~110 °F) PUHY - series	
Cooling	Inlet Water temp.	-	10~35 °C (50~95 °F)	

### 4. Confirmation of parts attached

- ① Strainer    ② Heat insulation material    ③ Connector sets × 2    ④ Expansion joint × 2 (PWFY-P200VM-E-AU)

### 5. Lifting method

#### ⚠ Caution:

**Be very careful when carrying the product.**

- Do not have only one person to carry product if it is more than 20 kg.
- PP bands are used to pack some products. Do not use them as a mean for transportation because they are dangerous.
- Tear plastic packaging bag and scrap it so that children cannot play with it. Otherwise plastic packaging bag may suffocate children to death.

### 6. Installation of unit and service space

#### 6.1. Installation

- Using the anchoring holes shown below, firmly bolt the unit to the base.

[Fig. 6.1.1] (P.2)

Ⓐ 4-φ14 (Anchoring hole) Ⓑ (Top view)

#### Bases

- Be sure to install unit in a place strong enough to withstand its weight. If the base is unstable, reinforce with a concrete base.
- The unit must be anchored on a level surface. Use a level to check after installation.
- If the unit is installed near a room where noise is a problem, using an anti-vibration stand on the base of the unit is recommended.

#### ⚠ Warning:

- **Be sure to install unit in a place strong enough to withstand its weight. Any lack of strength may cause unit to fall down, resulting in a personal injury.**
- **Have installation work in order to protect against earthquake. Any installation deficiency may cause unit to fall down, resulting in a personal injury.**

#### 6.2. Service space

- Please allow for the following service spaces after installation.  
(All servicing can be performed from the front of the unit)

[Fig. 6.2.1] (P.2)

Model	a	b	c
PWFY-P100VM-E-BU	400	300	600
PWFY-P100VM-E-AU	400	300	600
PWFY-P200VM-E-AU	400	300	600

- Ⓐ Piping space (right side)    Ⓑ Top view  
Ⓒ Service space (front side)

### 7. Water pipe installation

- Light pipes are similar to other air-conditioning pipes, however, please observe the following precautions during installation.
- Before a long period of non use, purge the water out of the pipes and thoroughly let them dry.
- Use a closed water circuit.
- When using the unit for cooling, add brine to the circulating water to prevent it from freezing.
- When installed in a low-ambient temperature environment, keep the water circulating at all times. If that is not possible, purge the water out of the pipes completely.

- Do not use the water used for this unit for drinking or food manufacturing.
- Do not use steel pipes as water pipes.
- When the ambient temperature is 0 °C or lower during stop operation, keep the water circulating at all times, or purge the water out of the pipes completely.

Model	Water inlet	Water outlet
PWFY-P100VM-E-BU	PT 3/4 Screw	PT 3/4 Screw
PWFY-P100VM-E-AU	PT 3/4 Screw	PT 3/4 Screw
PWFY-P200VM-E-AU *1 When the attached expansion joints are installed.	PT 1 Screw*1	PT 1 Screw*1

## 7.1. Precautions during installation

- Use the reverse-return method to insure proper pipe resistance to each unit.
- To insure easy maintenance, inspection, and replacement of the unit, use a proper joint, valve, etc. on the water intake and outlet port. In addition, be sure to install a strainer on the water intake pipe. (In order to maintain the heat source unit, a strainer on the circulating water inlet is necessary.)  
\* An example of the heat source unit installation is shown in the diagram below.
- Install a suitable air vent on the water pipe. After sending water through the pipe, be sure to vent the excess air.
- Compressed water may form in the low-temperature sections of heat source unit. Use a drainage pipe connected to the drain valve at the base of the unit to drain the water.
- Install a back flow-prevention valve on the pump and a flexible joint to prevent excess vibration.
- Use a sleeve to protect the pipes where they go through a wall.
- Use metal fittings to secure the pipes, and install them so that they have maximum protection against breakage and bending.
- Do not confuse the water intake and outlet valves.
- This unit doesn't have any heater to prevent freezing within tubes. When the water flow is stopped on low ambient, take out the water from tubes.
- The unused knockout holes should be closed and the opening of refrigerant pipes, water pipes, power source and transmission wires should be filled with putty and so on to prevent from rain. (field construction)
- Install the strainer at the angle of 45° or less as shown in [Fig.7.1.2].
- Wrap some sealing tape around the screw part to prevent water leakage.
- Install the supplied strainer at the water inlet.
- Hold the pipe on the unit side in place with a spanner when installing the pipes or strainer. Tighten screws to a torque of 50 N·m.
- Water pipes can get very hot, depending on the preset temperature. Wrap the water pipes with insulating materials to prevent burns.
- On the PWFY-P200VM-E-AU model, install the expansion joint (accessory) at the inlet after installing the strainer, and outlet.

### ② Water quality standard

Items	Lower mid-range temperature water system Water Temp. ≤ 60 °C		Higher mid-range temperature water system Water Temp. > 60 °C		Tendency		
	Recirculating water	Make-up water	Recirculating water	Make-up water	Corrosive	Scale-forming	
Standard items	pH (25 °C)	7.0 ~ 8.0	7.0 ~ 8.0	7.0 ~ 8.0	7.0 ~ 8.0	○	○
	Electric conductivity(mS/m) (25 °C) (μ s/cm) (25 °C)	30 or less [300 or less]	30 or less [300 or less]	30 or less [300 or less]	30 or less [300 or less]	○	○
	Chloride ion (mg Cl/ℓ)	50 or less	50 or less	30 or less	30 or less	○	
	Sulfate ion (mg SO <sub>4</sub> <sup>2-</sup> /ℓ)	50 or less	50 or less	30 or less	30 or less	○	
	Acid consumption (pH4.8) (mg CaCO <sub>3</sub> /ℓ)	50 or less	50 or less	50 or less	50 or less		○
	Total hardness (mg CaCO <sub>3</sub> /ℓ)	70 or less	70 or less	70 or less	70 or less		○
	Calcium hardness (mg CaCO <sub>3</sub> /ℓ)	50 or less	50 or less	50 or less	50 or less		○
Reference items	Ionic silica (mg SiO <sub>2</sub> /ℓ)	30 or less	30 or less	30 or less	30 or less		○
	Iron (mg Fe/ℓ)	1.0 or less	0.3 or less	1.0 or less	0.3 or less	○	○
	Copper (mg Cu/ℓ)	1.0 or less	1.0 or less	1.0 or less	1.0 or less	○	
	Sulfide ion (mg S <sup>2-</sup> /ℓ)	not to be detected	not to be detected	not to be detected	not to be detected	○	
	Ammonium ion (mg NH <sub>4</sub> <sup>+</sup> /ℓ)	0.3 or less	0.1 or less	0.1 or less	0.1 or less	○	
	Residual chlorine (mg Cl/ℓ)	0.25 or less	0.3 or less	0.1 or less	0.3 or less	○	
	Free carbon dioxide (mg CO <sub>2</sub> /ℓ)	0.4 or less	4.0 or less	0.4 or less	4.0 or less	○	
Ryzner stability index	-	-	-	-	○	○	

Reference : Guideline of Water Quality for Refrigeration and Air Conditioning Equipment. (JRA GL02E-1994)

- ③ Please consult with a water quality control specialist about water quality control methods and water quality calculations before using anti-corrosive solutions for water quality management.
- ④ When replacing a previously installed air conditioning device (even when only the heat exchanger is being replaced), first conduct a water quality analysis and check for possible corrosion.  
Corrosion can occur in cold-water systems even if there has been no prior signs of corrosion.  
If the water quality level has dropped, please adjust water quality sufficiently before replacing the unit.

## Example of unit installation (using light piping)

[Fig. 7.1.1] (P.2)

- Ⓐ Close valve
- Ⓑ Water inlet
- Ⓒ Water outlet
- Ⓓ Refrigerant piping
- Ⓔ Y-type strainer
- Ⓕ Drain pipe
- Ⓖ Expansion joint

## 7.2. Insulation installation

The surface temperature of the water pipe would be very high, depending on the set temperature. Insulate the pipe to prevent burns. When operating PWFY-P100/P200VM-E-AU with cold water, insulate the water pipe to prevent condensation. Wrap insulation material around water pipes as shown in [Fig. 7.2.1].

- Any heat source piping.
- Indoor piping in cold-weather regions where frozen pipes are a problem.
- When air coming from the outside causes condensation to form on piping.
- Any drainage piping.

[Fig. 7.2.1] (P.2)

- Ⓐ Heat insulation material (accessory)
- Ⓑ Inject with cooling material

## 7.3. Water processing and water quality control

To preserve water quality, use the closed type of cooling tower for unit. When the circulating water quality is poor, the water heat exchanger can develop scales, leading to a reduction in heat-exchange power and possible corrosion of the heat exchanger. Please pay careful attention to water processing and water quality control when installing the water circulation system.

- Removal of foreign objects or impurities within the pipes.  
During installation, be careful that foreign objects, such as welding fragments, sealant particles, or rust, do not enter the pipes.
- Water Quality Processing
  - ① Depending on the quality of the cold-temperature water used in the air conditioner, the copper piping of the heat exchanger may become corroded. We recommend regular water quality processing.  
Cold water circulation systems using open heat storage tanks are particularly prone to corrosion.  
When using an open-type heat storage tank, install a water-to-water heat exchanger, and use a closed-loop circuit on the air conditioner side. If a water supply tank is installed, keep contact with air to a minimum, and keep the level of dissolved oxygen in the water no higher than 1mg/ℓ.

## 7.4. Pump interlock

The unit may become damaged if it is operated with no water circulating through the pipes.

Be sure to interlock unit operation and the water-circuit pump. Use the terminal blocks for interlocking TB142A (IN1) that can be found on the unit.

[Fig. 7.4.1] (P.2)



## 8. Refrigerant pipe and drain pipe specifications

To avoid dew drops, provide sufficient antisweating and insulating work to the refrigerant and drain pipes.

When using commercially available refrigerant pipes, be sure to wind commercially available insulating material (with a heat-resisting temperature of more than

100 °C and thickness given below) onto both liquid and gas pipes.

Be also sure to wind commercially available insulating material (with a form polyethylene's specific gravity of 0.03 and thickness given below) onto all pipes which pass through rooms.

① Select the thickness of insulating material by pipe size.

Model	PWFY-P100VM-E-BU	PWFY-P100VM-E-AU	PWFY-P200VM-E-AU
Gas	ø15.88	ø15.88	ø19.05
Liquid	ø9.52	ø9.52	ø9.52
Drain	ø32		
Insulating material's thickness	More than 10 mm		

② If the unit is used on the highest story of a building and under conditions of high temperature and humidity, it is necessary to use pipe size and insulating material's thickness more than those given in the table above.

③ If there are customer's specifications, simply follow them.

### 8.1. Refrigerant pipe, drain pipe and filling port

[Fig. 8.1.1] (P. 3)

- Ⓐ Refrigerant piping (gas)
- Ⓑ Refrigerant piping (liquid)
- Ⓒ Water inlet
- Ⓓ Water outlet
- Ⓔ Drain outlet
- \*1: PWFY-P100/200VM-E-AU

## 9. Connecting refrigerant pipes and drain pipes

### 9.1. Refrigerant piping work

This piping work must be done in accordance with the installation manuals for both outdoor unit and BC controller (simultaneous cooling and heating series R2).

- Series R2 is designed to operate in a system that the refrigerant pipe from an outdoor unit is received by BC controller and branches at the BC controller to connect between indoor units.
- For constraints on pipe length and allowable difference of elevation, refer to the outdoor unit manual.
- The method of pipe connection is brazing connection.

#### ⚠ Caution:

- Install the refrigerant piping for the indoor unit in accordance with the following.

1. Cut the tip of the indoor unit piping, remove the gas, and then remove the brazed cap.

[Fig. 9.1.1] (P.3)

- Ⓐ Cut here
- Ⓑ Remove brazed cap

2. Pull out the thermal insulation on the site refrigerant piping, braze the unit piping, and replace the insulation in its original position. Wrap the piping with insulating tape.

#### Note:

- Pay strict attention when wrapping the copper piping since wrapping the piping may cause condensation instead of preventing it.

\* Before brazing the refrigerant piping, **always wrap the piping on the main body, and the thermal insulation piping, with damp cloths to prevent heat shrinkage and burning the thermal insulation tubing.** Take care to ensure that the flame does not come into contact with the main body itself.

[Fig. 9.1.2] (P.3)

- Ⓐ Thermal insulation
- Ⓑ Pull out insulation
- Ⓒ Wrap with damp cloth
- Ⓓ Return to original position
- Ⓔ Ensure that there is no gap here
- Ⓕ Wrap with insulating tape

### Cautions On Refrigerant Piping

- ▶ Be sure to use non-oxidative brazing for brazing to ensure that no foreign matter or moisture enter into the pipe.
- ▶ Be sure to apply refrigerating machine oil over the flare connection seating surface and tighten the connection using a double spanner.
- ▶ Provide a metal brace to support the refrigerant pipe so that no load is imparted to the indoor unit end pipe. This metal brace should be provided 50 cm away from the indoor unit's flare connection.

#### ⚠ Warning:

When installing and moving the unit, do not charge it with refrigerant other than the refrigerant (R407C or R22) specified on the unit.

- Mixing of a different refrigerant, air, etc. may cause the refrigerant cycle to malfunction and result in severe damage.

#### ⚠ Caution:

- Use refrigerant piping made of C1220 (CU-DHP) phosphorus deoxidized copper as specified in the JIS H3300 "Copper and copper alloy seamless pipes and tubes". In addition, be sure that the inner and outer surfaces of the pipes are clean and free of hazardous sulphur, oxides, dust/dirt, shaving particles, oils, moisture, or any other contaminant.
- Never use existing refrigerant piping.
  - The large amount of chlorine in conventional refrigerant and refrigerant oil in the existing piping will cause the new refrigerant to deteriorate.
- Store the piping to be used during installation indoors and keep both ends of the piping sealed until just before brazing.
  - If dust, dirt, or water gets into the refrigerant cycle, the oil will deteriorate and the compressor may fail.

## 9.2. Drain piping work

1. Ensure that the drain piping is downward (pitch of more than 1/100) to the outdoor (discharge) side. Do not provide any trap or irregularity on the way. (Ⓐ)
2. Ensure that any cross-wise drain piping is less than 20 m (excluding the difference of elevation). If the drain piping is long, provide metal braces to prevent it from waving. Never provide any air vent pipe. Otherwise drain may be ejected.
3. Use a hard vinyl chloride pipe VP-25 (with an external diameter of 32 mm) for drain piping.
4. Ensure that collected pipes are 10 cm lower than the unit body's drain port as shown in (Ⓑ).
5. Do not provide any odor trap at the drain discharge port.
6. Put the end of the drain piping in a position where no odor is generated.
7. Do not put the end of the drain piping in any drain where ionic gases are generated.

[Fig. 9.2.1] (P. 3)

- (A) Downward slope 1/100 or more
- (B) Drain hose
- (C) Unit
- (D) Collective piping
- (E) Maximize this length to approx. 10 cm

## 9.3. Connecting electrical connections

Verify that the model name on the operating instructions on the cover of the control box is the same as the model name on the nameplate.

### Step 1

Remove the screws holding the terminal box cover in place.

[Fig. 9.3.1] (P. 3)

- (A) Screws
- (B) Front panel
- (C) Control box

## 10. Electrical wiring

### Precautions on electrical wiring

#### ⚠ Warning:

Electrical work should be done by qualified electrical engineers in accordance with "Engineering Standards For Electrical Installation" and supplied installation manuals. Special circuits should also be used. If the power circuit lacks capacity or has an installation failure, it may cause a risk of electric shock or fire.

1. Be sure to take power from the special branch circuit.
2. Be sure to install an earth leakage breaker to the power.
3. Install the unit to prevent that any of the control circuit cables (remote controller, transmission cables, or external input/output line) is brought in direct contact with the power cable outside the unit.
4. Ensure that there is no slack on all wire connections.
5. Some cables (power, remote controller, transmission cables external input/output line) above the ceiling may be bitten by mice. Use as many metal pipes as possible to insert the cables into them for protection.

#### 1. Transmission cables

PWFY-P100VM-E-BU

	Transmission cables	MA Remote controller cables	External input	External output
Type of cable	Shielding wire (2-core) CVVS, CPEVS or MVVS	Sheathed 2-core cable (shielded) CVVS	Sheathed multi-core cable (shielded) CVVS or MVVS	Sheathed multi-core cable (unshielded) CVV or MVV
Cable diameter	More than 1.25 mm <sup>2</sup>	0.3 ~ 1.25 mm <sup>2</sup> (0.75 ~ 1.25 mm <sup>2</sup> )*1	0.3 ~ 0.5 mm <sup>2</sup>	0.3 ~ 1.25 mm <sup>2</sup>
Remarks	-	Max.length: 200 m	Max.length: 100 m	Rated voltage: L1-N: 220 ~ 240 V Rated load: 1 A

PWFY-P100/200VM-E-AU

	Transmission cables	MA Remote controller cables	External input	External output
Type of cable	Shielding wire (2-core) CVVS, CPEVS or MVVS	Sheathed 2-core cable (shielded) CVVS (unshielded)	Sheathed multi-core cable CVV or MVV (unshielded)	Sheathed multi-core cable (unshielded) CVV or MVV
Cable diameter	More than 1.25 mm <sup>2</sup>	0.3 ~ 1.25 mm <sup>2</sup> (0.75 ~ 1.25 mm <sup>2</sup> )*1	0.3 ~ 0.5 mm <sup>2</sup>	0.3 ~ 1.25 mm <sup>2</sup>
Remarks	-	Max.length: 200 m	Max.length: 100 m	Rated voltage: L1-N: 220 ~ 240 V Rated load: 1 A

\*1 Connected with simple remote controller. CVVS, MVVS: PVC insulated PVC jacketed shielded control cable

CVV, MVV : PVC insulated PVC sheathed control cable

CPEVS : PE insulated PVC jacketed shielded communication cable

#### Note:

Ensure that the wiring is not pinched when fitting the terminal box cover. Pinching the wiring may cut it.

#### ⚠ Caution:

Install wiring so that it is not tight and under tension. Wiring under tension may break, or overheat and burn.

- Fix power source external input/output line wiring to control box by using buffer bushing for tensile force to prevent electric shock. (PG connection or the like.) Connect transmission wiring to transmission terminal block through the knock-out hole of control box using ordinary bushing.
- After wiring is complete, make sure again that there is no slack on the connections, and attach the cover onto the control box in the reverse order removal.

[Fig. 9.3.2] (P. 3)

- (A) To prevent external tensile force from applying to the wiring connection section of power source terminal block use buffer bushing like PG connection or the like.
- (B) External signal input cable
- (C) External signal output cable
- (D) Power source wiring
- (E) Tensile force
- (F) Use ordinary bushing
- (G) Transmission cable and MA remote controller cable

#### ⚠ Caution:

Wire the power supply so that no tension is imparted. Otherwise disconnection, heating or fire result.

6. Never connect the power cable to leads for the transmission cables. Otherwise the cables would be broken.
7. Be sure to connect control cables to the indoor unit, remote controller, and the outdoor unit.
8. Be sure to ground the unit.
9. Select control cables from the conditions given in page 10.

#### ⚠ Caution:

Be sure to put the unit to the ground on the outdoor unit side. Do not connect the earth cable to any gas pipe, water pipe, lightning rod, or telephone earth cable. Incomplete grounding may cause a risk of electric shock.

### Types of control cables

#### 1. Wiring transmission cables

- Types of transmission cables

Design wiring in accordance with the following table <Table 1>.

## 10.1. Power supply wiring

- Power supply cords of appliances shall not be lighter than design 245 IEC 57 or 227 IEC 57.
- A switch with at least 3 mm contact separation in each pole shall be provided by the Air conditioner installation.

### ELECTRICAL WORK

#### 1. Electrical characteristics

Model	Power supply				Compressor		RLA (A)
	Hz	Volts	Voltage range	MCA (A)	Output (kW)	SC (A)	Heating
PWFY-P100VM-E-BU	50/60	220-230-240 V	Max. 264 V Min. 198 V	15.71	1.0	1.25	11.63-11.12-10.66

Model	Power supply				RLA (A)	
	Hz	Volts	Voltage range	MCA (A)	Cooling	Heating
PWFY-P100VM-E-AU PWFY-P200VM-E-AU	50/60	220-230-240 V	Max. 264 V Min. 198 V	0.085	0.068-0.065-0.063	

#### 2. Power cable specifications

Model	Minimum wire thickness (mm <sup>2</sup> )			Breaker for current leakage	Local switch (A)		Breaker for wiring (NFB) (A)
	Main cable	branch	Ground		capacity	fuse	
PWFY-P100VM-E-BU	2.5	-	2.5	30 A 30 mA 0.1 sec or less	25	25	30

Model	Total operating current	Minimum wire thickness (mm <sup>2</sup> )			Breaker for current leakage	Local switch (A)		Breaker for wiring (NFB) (A)	
		16 A or less	25 A or less	32 A or less		capacity	fuse		
PWFY-P100VM-E-AU		16 A or less	1.5	1.5	1.5	20 A 30 mA 0.1 sec. or less	16	16	20
PWFY-P200VM-E-AU		25 A or less	2.5	2.5	2.5	30 A 30 mA 0.1 sec. or less	25	25	30
		32 A or less	4.0	4.0	4.0	40 A 30 mA 0.1 sec. or less	32	32	40

[Fig. 10.1.1] (P. 4)

- Ⓐ Breaker for current leakage
- Ⓑ Local switch or breakers for wiring
- Ⓒ PWFY-P100VM-E-AU
- Ⓓ PWFY-P100/200VM-E-AU
- Ⓔ Pull box

#### ⚠ Caution:

Do not use anything other than the correct capacity breaker and fuse. Using fuse, wire or copper wire with too large capacity may cause a risk of malfunction or fire.

## 10.2. Connecting remote controller, indoor and outdoor transmission cables

(Remote controller is optionally available.)

- Connect unit TB5 and outdoor unit TB3. (Non-polarized 2-wire (shield))  
The "S" on unit TB5 is a shielding wire connection. For specifications about the connecting cables, refer to the outdoor unit installation manual.
- Install a remote controller following the manual supplied with the remote controller.
- Connect the "1" and "2" on unit TB15 to a MA remote controller. (Non-polarized 2-wire)

[Fig. 10.2.1] (P.4) MA Remote controller

- DC 10 to 13 V between 1 and 2 (MA remote controller)

[Fig. 10.2.2] (P.4) MA Remote controller

- The MA remote controller cannot be used at the same time or interchangeably.
  - Ⓐ Non-polarized
  - Ⓑ TB15 (MA remote controller cables)
  - Ⓒ MA remote Controller
  - Ⓓ TB5 (Transmission cables)
  - Ⓔ TB2 (Power supply wiring)

#### Note:

Ensure that the wiring is not pinched when fitting the terminal box cover. Pinching the wiring may cut it.

#### ⚠ Caution:

- Use wire with supplemental insulation.
- Input to TB142A, TB142B, and TB142C should not carry voltage.
- Cables from equipment connected to external input/output should have supplemental insulation.
- Use a single multiple-core cable for external input/output to allow for connection to the PG screw.

#### ⚠ Caution:

Wire the power supply so that no tension is imparted. Otherwise disconnection, heating or fire result.

## 10.3. External input/output function

#### Preset temperature input (external analog input: 4mA-20mA)

External input is input through CN421, CN422 on the circuit board. (Fig. 10.3.1) Use the supplied connector.

If no temperature settings are made via the MA remote controller, the temperature changes with the current.

Refer to the instructions manual that came with the MA remote controller for how to make the settings.

4 mA → 10 °C      20 mA → 70 °C

#### External output terminal

External output terminal (refer to Fig. 10.3.2) is ineffective when the circuit is open. Refer to Table 10.3.2 for information about each contact.

The current in the circuit to be connected to the external output terminal must be 0.6A or less.

Table 10.3.2

OUT1	Operation ON/OFF
OUT2	Defrost
OUT3	Compressor
OUT4	Error signal

#### External input terminal

The piping length must be within 100 m.

External input terminal (refer to Fig. 10.3.3) is ineffective when the circuit is open. Refer to Table 10.3.3 through Table 10.3.5 for information about each contact.

Only the "pump interlock" function is ineffective when the circuit is short-circuited. Connect a relay circuit to the external output terminal as shown in Fig. 7.4.1.

The specifications of the relay circuit to be connected must meet the following conditions.

Contact rating voltage ≥ DC15V

Contact rating current ≥ 0.1A

Minimum applicable load ≤ 1mA at DC

Table 10.3.3

TB142A	
IN1	Pump interlock

Table 10.3.4

TB142B	
IN3	Connection demand
IN4	Operation ON/OFF

Table 10.3.5

TB142C	
COM+	Common
IN5*1	Hot Water/Heating
IN6*2	Heating ECO
IN7*3	Anti-freeze

\*1 PWFY-P100VM-E-BU      Hot Water  
PWFY-P100V/200M-E-AU      Heating

\*2 Effective when SW 4-3 is set to ON.

\*3 Effective when SW 4-4 is set to ON.

## 10.4. Setting addresses

(Be sure to operate with the main power turned OFF.)

### [Fig. 10.4.1] (P. 4)

<Address board>

- There are two types of rotary switch setting available: setting addresses 1 to 9 and over 10, and setting branch numbers.

#### ① How to set addresses

Example: If Address is "3", remain SWU2 (for over 10) at "0", and match SWU1 (for 1 to 9) with "3".

#### ② How to set branch numbers SWU3 (Series R2 only)

Match the indoor unit's refrigerant pipe with the BC controller's end connection number. Remain other than R2 at "0".

- The rotary switches are all set to "0" when shipped from the factory. These switches can be used to set unit addresses and branch numbers at will.
- The determination of indoor unit addresses varies with the system at site. Set them referring to the DATA BOOK.

## 11. Information on rating plate

Model		PWFY-P100VM-E-BU	PWFY-P100VM-E-AU	PWFY-P200VM-E-AU
Refrigerant (kg)	R134a	1.1	-	-
	R410A	4.15	4.15	4.15
Allowable pressure (MPa)	R134a	3.60	-	-
	water	1.0	1.0	1.0
Net weight (kg)		60	35	38







---

This product is designed and intended for use in the residential, commercial and light-industrial environment.

The product at hand is based on the following EU regulations:

- Low Voltage Directive 73/23/EEC
- Electromagnetic Compatibility Directive 2004/108/EC

Please be sure to put the contact address/telephone number on this manual before handing it to the customer.

 **mitsubishi electric corporation**

HEAD OFFICE: TOKYO BLDG., 2-7-3, MARUNOUCHI, CHIYODA-KU, TOKYO 100-8310, JAPAN

Authorized representative in EU: MITSUBISHI ELECTRIC EUROPE B.V.

HARMAN HOUSE, 1 GEORGE STREET, UXBRIDGE, MIDDLESEX UB8 1QQ, U.K.